

Thermomagnetic device circuit breaker - TMC 83D 08A - 2907683

Please be informed that the data shown in this PDF Document is generated from our Online Catalog. Please find the complete data in the user's documentation. Our General Terms of Use for Downloads are valid (<http://phoenixcontact.com/download>)



Thermomagnetic device circuit breaker, number of positions: 3, connection method: Screw, cross section: 1 mm²- 35 mm², AWG: 18 - 2, width: 52.9 mm, mounting type: DIN rail, Color: gray



Key Commercial Data

Packing unit	1 pc
GTIN	 4 055626 216300
GTIN	4055626216300
Weight per Piece (excluding packing)	420.000 g
Country of origin	China

Technical data

General

Mounting type	DIN rail
Color	gray
Number of positions	3

Electrical data

Operating voltage	240 V AC (277/480Y, 240D)
Rated current I_N	8 A
Rated short-circuit switching capacity I_{cn}	10 kA (IC)

Dimensions

Height	116 mm
Width	52.9 mm
Depth	65.7 mm

Thermomagnetic device circuit breaker - TMC 83D 08A - 2907683

Technical data

Ambient conditions

Ambient temperature (operation)	-35 °C ... 70 °C
---------------------------------	------------------

Connection data

Conductor cross section solid min.	1 mm ²
Conductor cross section solid max.	35 mm ²
Conductor cross section flexible min.	1 mm ²
Conductor cross section flexible max.	35 mm ²
Conductor cross section AWG min.	18
Conductor cross section AWG max.	2
Connection method	Screw
Tightening torque max	2 Nm

Standards and Regulations

Standards/specifications	UL 489 IEC 60947-2
--------------------------	--------------------

Environmental Product Compliance

REACH SVHC	Lead 7439-92-1
	Cadmium oxide 1306-19-0

Drawings

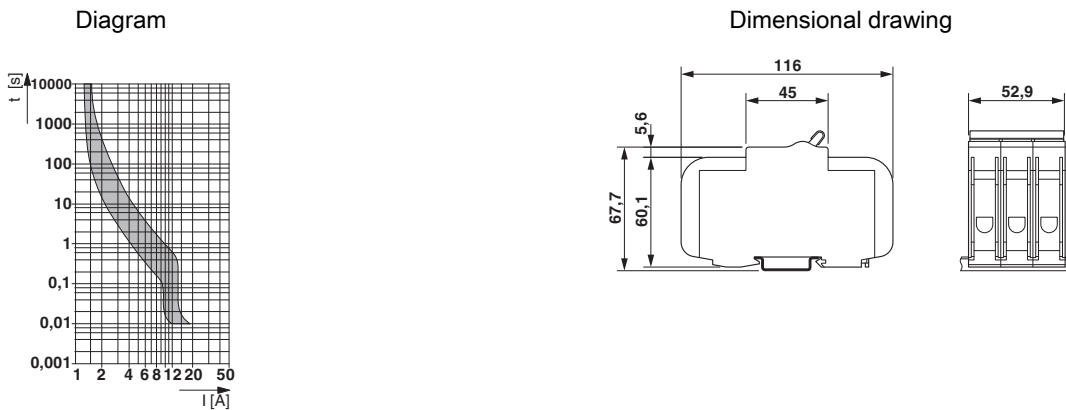

Classifications

eCl@ss

eCl@ss 10.0.1	27141116
eCl@ss 11.0	27141116
eCl@ss 4.0	27141116
eCl@ss 4.1	27141116

Thermomagnetic device circuit breaker - TMC 83D 08A - 2907683

Classifications

eCl@ss

eCl@ss 5.0	27141116
eCl@ss 5.1	27141100
eCl@ss 6.0	27141100
eCl@ss 7.0	27141116
eCl@ss 9.0	27141116

ETIM

ETIM 3.0	EC000899
ETIM 4.0	EC000899
ETIM 6.0	EC000899
ETIM 7.0	EC000899

UNSPSC

UNSPSC 6.01	30211812
UNSPSC 7.0901	39121411
UNSPSC 11	39121411
UNSPSC 12.01	39121411
UNSPSC 13.2	39121620
UNSPSC 18.0	39121410
UNSPSC 19.0	39121410
UNSPSC 20.0	39121410
UNSPSC 21.0	39121410

Approvals

Approvals

Approvals

UL Listed / cUL Listed / cULus Listed

Ex Approvals

Approval details

UL Listed		http://database.ul.com/cgi-bin/XYV/template/LISEXT/1FRAME/index.htm	FILE E 320373
-----------	--	---	---------------

Thermomagnetic device circuit breaker - TMC 83D 08A - 2907683

Approvals

cUL Listed		http://database.ul.com/cgi-bin/XYV/template/LISEXT/1FRAME/index.htm	FILE E 320373
------------	--	---	---------------

cULus Listed			
--------------	--	--	--

Accessories

Accessories

Bridge

Wiring bridge - TMC 8 B3 80 57 C - 2907996



Bus bar for TMC 83... circuit breakers (three phase) 17.8 mm pitch, up to 57 positions. Rated for 80 A (end feed) 600 V AC/DC. UL 508 Listed for connection of UL 489 rated circuit breakers.

Wiring bridge - TMC 8 B3 80 48 CA - 2907997



Bus bar for TMC 83... circuit breakers (three phase) with auxilliary switch. 17.8 mm pitch, up to 48 positions. Rated for 80 A (end feed) 600 V AC/DC. UL 508 Listed for connection of UL 489 rated circuit breakers.

Device marking

Label - EML (10X4)R - 0815583



Label, Roll, white, unlabeled, can be labeled with: THERMOMARK ROLLMASTER 300/600, THERMOMARK X1.2, THERMOMARK ROLL X1, THERMOMARK ROLL 2.0, THERMOMARK ROLL, mounting type: adhesive, lettering field size: 10 x 4 mm, Number of individual labels: 10000

Terminal marking

Thermomagnetic device circuit breaker - TMC 83D 08A - 2907683

Accessories

Marking foil for zack marker strip - TML (104X3,8)R - 0801833



Marking foil for zack marker strip, Roll, white, unlabeled, can be labeled with: THERMOMARK ROLL 2.0, THERMOMARK ROLL, THERMOMARK ROLL X1, THERMOMARK ROLLMASTER 300/600, THERMOMARK X1.2, mounting type: adhesive, for terminal block width: 104 mm, lettering field size: 104 x 3.8 mm, Number of individual labels: 2500

Terminal adapter - TMC 8 B TERM PIN - 2907998



Feeder terminal adapter for TMC 8..... circuit breaker bus bars. Rated for 1000 V AC/DC, 115 A. Wire range 14...2 AWG. UL Listed for connection to UL 489 rated circuit breakers.

Wiring bridge end cover - TMC 8 B END CAP - 2907999



Protective end covers for TMC 8 bus bars

Protective covers - TMC 8 B BUS CAP - 2908000



Protective covers for TMC 8 bus bars. Cuttable, three positions, yellow.

Thermomagnetic device circuit breaker - TMC 7/8 AUX - 2908219



Thermomagnetic device circuit breaker, number of positions: 1, connection method: Screw, cross section: 1 mm²- 35 mm², AWG: 18 - 2, width: 9 mm, mounting type: Snaps on to side of circuit breaker, Color: gray

Thermomagnetic device circuit breaker - TMC 83D 08A - 2907683

Accessories

Thermomagnetic device circuit breaker - TMC 7/8 ALARM - 2908220



Thermomagnetic device circuit breaker, number of positions: 1, connection method: Screw, cross section: 1 mm²- 35 mm², AWG: 18 - 2, width: 9 mm, mounting type: Snaps on to side of circuit breaker, Color: gray

Thermomagnetic device circuit breaker - TMC 7/8 12VDC SHNT - 2908221



Thermomagnetic device circuit breaker, number of positions: 1, connection method: Screw, cross section: 1 mm²- 35 mm², AWG: 18 - 2, width: 18 mm, mounting type: Snaps on to side of circuit breaker, Color: gray

Thermomagnetic device circuit breaker - TMC 7/8 24VDC SHNT - 2908222



Thermomagnetic device circuit breaker, number of positions: 1, connection method: Screw, cross section: 1 mm²- 35 mm², AWG: 18 - 2, width: 18 mm, mounting type: Snaps on to side of circuit breaker, Color: gray

Thermomagnetic device circuit breaker - TMC 7/8 48VDC SHNT - 2908224



Thermomagnetic device circuit breaker, number of positions: 1, connection method: Screw, cross section: 1 mm²- 35 mm², AWG: 18 - 2, width: 18 mm, mounting type: Snaps on to side of circuit breaker, Color: gray

Thermomagnetic device circuit breaker - TMC 7/8 125VDC SHNT - 2908225



Thermomagnetic device circuit breaker, number of positions: 1, connection method: Screw, cross section: 1 mm²- 35 mm², AWG: 18 - 2, width: 18 mm, mounting type: Snaps on to side of circuit breaker, Color: gray

Thermomagnetic device circuit breaker - TMC 83D 08A - 2907683

Accessories

Thermomagnetic device circuit breaker - TMC 7/8 120VAC SHNT - 2908226



Thermomagnetic device circuit breaker, number of positions: 1, connection method: Screw, cross section: 1 mm²- 35 mm², AWG: 18 - 2, width: 18 mm, mounting type: Snaps on to side of circuit breaker, Color: gray

Thermomagnetic device circuit breaker - TMC 7/8 240VAC SHNT - 2908227



Thermomagnetic device circuit breaker, number of positions: 1, connection method: Screw, cross section: 1 mm²- 35 mm², AWG: 18 - 2, width: 18 mm, mounting type: Snaps on to side of circuit breaker, Color: gray

Thermomagnetic device circuit breaker - TMC 7/8 277VAC SHNT - 2908228



Thermomagnetic device circuit breaker, number of positions: 1, connection method: Screw, cross section: 1 mm²- 35 mm², AWG: 18 - 2, width: 18 mm, mounting type: Snaps on to side of circuit breaker, Color: gray
